

Laser Engrave Machine HL-1060 100W Manual



Table of Contents

Section I. Safety First	3
Fire Warning	3
Laser Safety.....	4
Electrical Safety	5
Section II. Uncrating HL-100W 1060	6
Uncrating HL-100W 1060.....	6
Parts & Accessories	7
Section III. Installation & Assembly	8
Connect the Exhaust.....	8
Connect the Water Chiller& Air Compressor	9
Connect Electrical Power	9
Connecting USB Cable	10
Remove ties from Machine belts	10
Section IV. Software	11
RDWorkV8 Installment	11
RDWorksV8 Interface Briefly	15
Section V. Operations	16
PC Connection Test.....	16
Origin setting& Z height positioning.....	17
Pilot Run Test	19
U Disk Operation.....	22
Section VI. FAQ	25



Fire Warning

The laser system uses a high intensity beam of light that can generate extremely high temperatures when it comes into contact with the material being engraved, marked or cut.

Some materials are extremely flammable and can easily ignite and burst into open flame setting the machine afire. This open flame is very dangerous and has the potential to destroy not only the machine, but the building in which it is housed.

Experience shows that vector cutting with the laser has the most potential to create an open flame. Many materials are susceptible to igniting, but acrylic, in all its different forms, has been shown to be especially flammable when vector cutting with the laser. Please read the following warnings and recommendations and follow them closely at all times!

- **Stay with the laser.** Never operate the laser system while unattended.
- **Keep the area clear.** Clean around the machine and keep the area free of clutter, combustible materials, explosives, or volatile solvents such as acetone, alcohol, or gasoline.
- **Be prepared with a fire extinguisher.** Always keep a properly maintained and inspected fire extinguisher on hand. This laser recommends a Halotron fire extinguisher or a multi-purpose dry chemical fire extinguisher. The Halotron extinguishers are more expensive than a dry chemical, but offer certain advantages should you ever need to use an extinguisher. The Halotron extinguisher discharges a clean, easily removable substance that is not harmful to the mechanics or wiring of the laser system. The dry chemical extinguisher discharges a sticky, corrosive powder that is very difficult to clean up.
- **Use Air Assist.** Always use the system's Air Assist feature when vector cutting.
- **Use caution when vector cutting.** Many materials have the potential to suddenly burst into flames when cut with a laser – even materials that may be very familiar to the user. Always monitor the machine when it is operating.
- **Clean the laser.** A buildup of cutting and engraving residue and debris is dangerous and can create a fire hazard in its own right. Keep your laser system clean and free of debris. Regularly remove the Vector Cutting Table to clean any small pieces that have fallen through the grid.



Laser Safety

The operator of our laser engraving should observe the following general precautions:

- **DO NOT disassemble the machine or remove any of its protective covers while the unit is plugged in.**
- **DO NOT** operate the machine with any of the panels removed. Be aware that removal of any portion of the cabinet will expose the laser system and greatly increase the risk of injury and/or fire. Personal injury and fire risks are especially pronounced if the machine is operated with any panel removed.
- **DO NOT attempt to defeat the door interlocks.**
- **DO NOT view directly into the beam of the Laser Diode Pointer (Red Dot Pointer).**
- **DO NOT operate the Laser Diode Pointer (Red Dot Pointer) without the machine's focus lens in place. If the unfocused beam strikes a reflective surface, it could be directed out of the cabinet.**
- . **DO NOT make or break any electrical connections to the system while the unit is turned on.**
- . **DO NOT engrave or cut any unknown material. The vaporization/melting of many materials, including but not limited to PVC and polycarbonates, can give off hazardous fumes. Please refer to the MSDS sheet from the material manufacturer to determine the response of any work material to extreme heat (burning/fire hazard).**
- . **DO NOT** engrave or cut any material containing PVC or vinyl. These materials (along with other chlorine/ chloride containing materials) produce a corrosive vapor that is extremely harmful to humans and will destroy your machine. Your warranty will be void if your machine is damaged by corrosion from engraving or cutting PVC or vinyl.
- . **DO NOT** look into the beam of the alignment laser (visible red diode laser).

Do's

Clean the System: Please allow a few minutes a week for cleaning your machine. Just a small amount of effort at the end of the week will pay off with years of trouble free operation of your machine.



Electrical Safety

The power supply is capable of outputting DC 20,000V at up to 30mA—always make sure to give the supply capacitors adequate time to discharge before accessing the electronics area. This power is also provided to the discharge terminals on the laser tube itself.

- . **DO NOT** open any of the machine's access panels while the unit is plugged in. Opening a panel may expose the operator to the unit's AC input power.
- . **DO NOT** make or break any electrical connections to the system while the unit is turned on.
- . **DO NOT** access the electronics area with hands or tools unless the unit is disconnected from power for at least two hours.
- . **DO NOT** replace the installed 10 amp fuse with a fuse of a higher rating. This will void your warranty and the electronics will not be adequately protected from surges or short circuits.

Section II. Uncrating HL-100W 1060

1. Uncrating HL-100W 1060
Crate size is on the right. That needs to lift it from one side and pull out this machine.

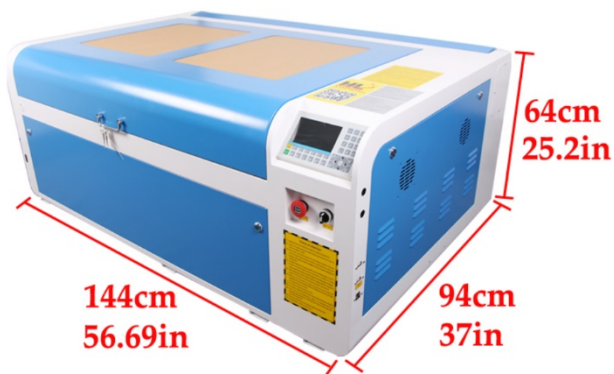

Machine size on the left

Machine front

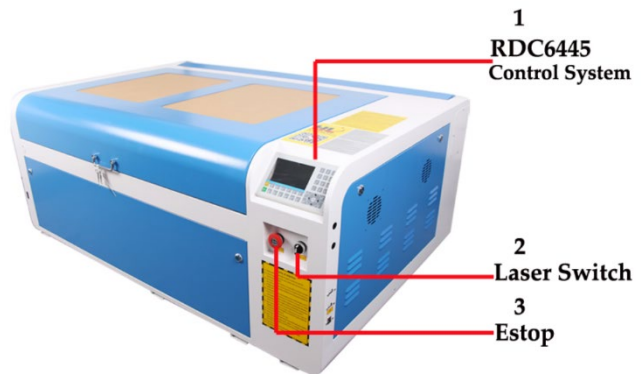

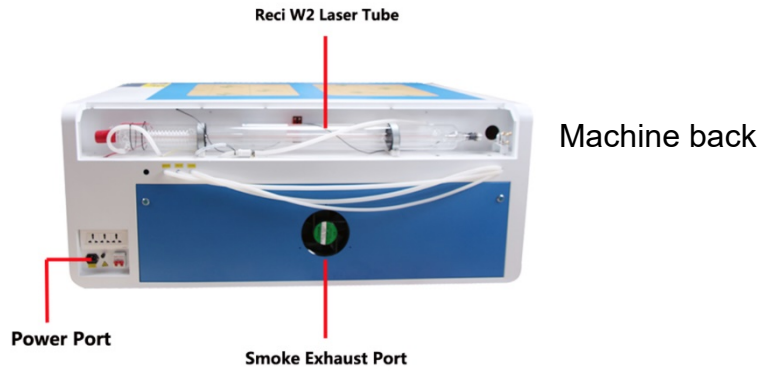

Machine control unit



2. Parts & Accessories

			
HL-1060L 100W DSP Laser Machine	CW5000 Chiller	Rotary axis	Air pump
			
Honeycomb platform	Air exhaust tube	Wheels	Spare key/limit switch/open cover protection switch
			
Electric iron	Multimeter	Glasses	USB cable & Ethernet cable & Power cord

Section III. Installation & Assembly

1. Connect the Exhaust(Optional part, buy separately)



2. Connect the Water Chiller& Air Compressor

CO2 Laser machines use water cooling laser tubes. Laser technology is such that the laser tubes generate a lot of excess heat and the tubes must be cooled for proper operation. Equipment running environment humidity: 5%~95% (free of condensed water) Keep the temperature of the water chiller between 5°C~40°C

- a. Laser Machine Water OUT to Chiller INLET
- b. Laser Machine Water IN to Chiller OUTLET
- c. Laser Machine Into Air to Air Compressor

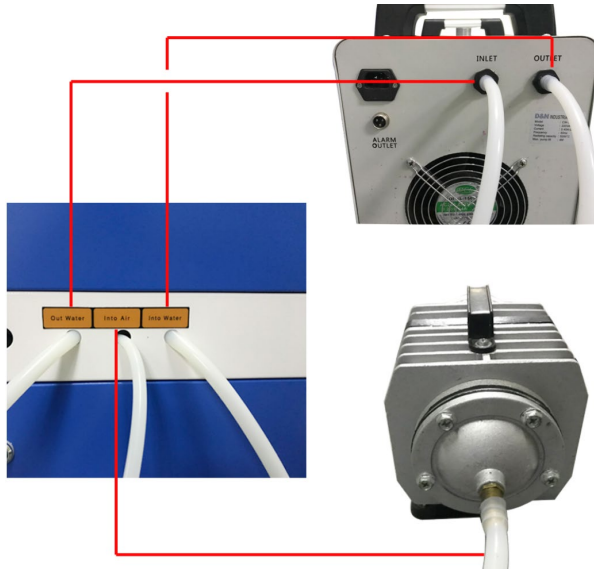

3. Connect Electrical Power



4. Connecting PC via USB Cable or RJ45 Ethernet Cable

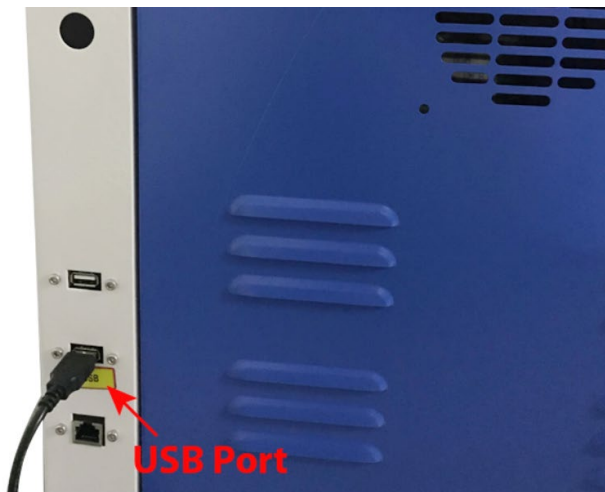

5. Remove ties on belts

For transportation safety, ties were implemented to fixed machine belts avoiding unexpected movement.

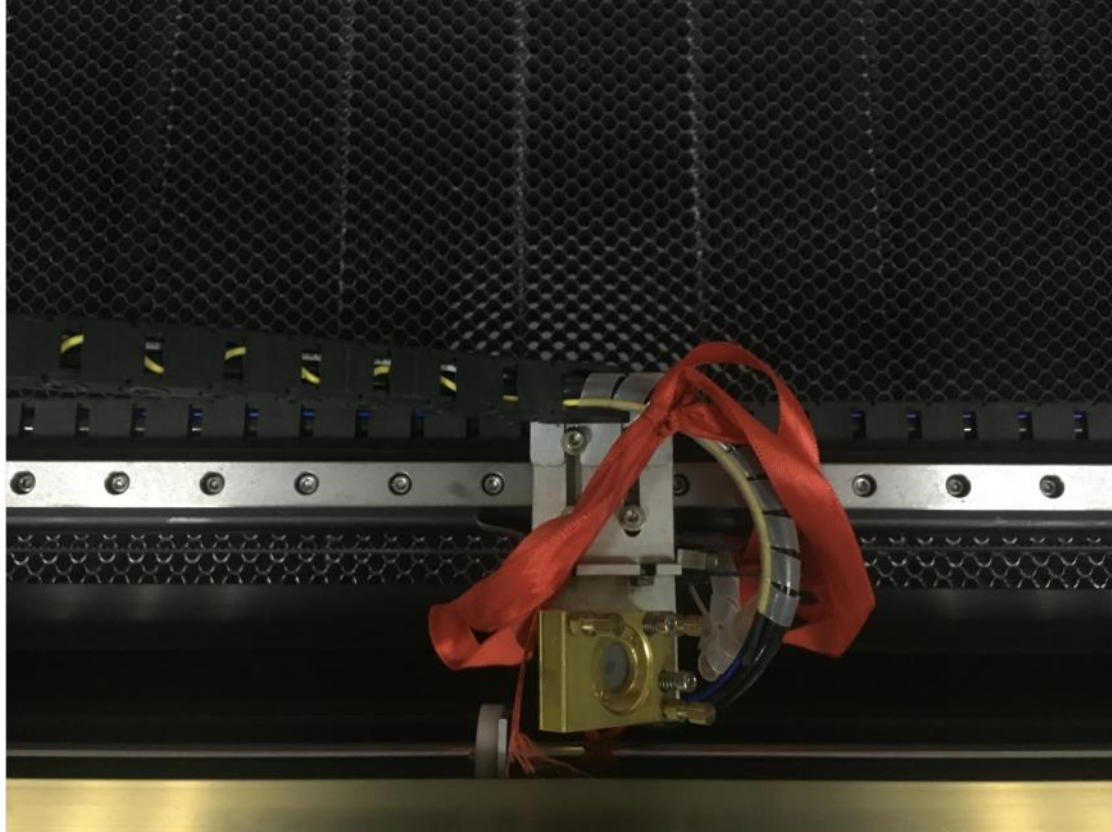

Section IV. Software

1. RDWorkV8 Installment

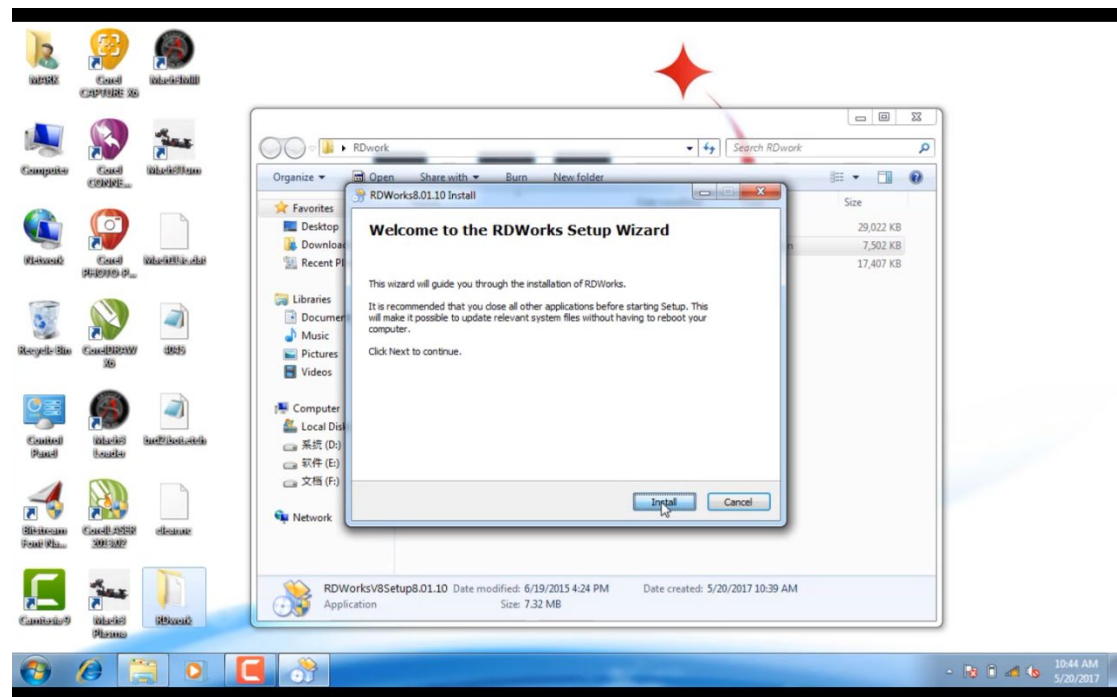
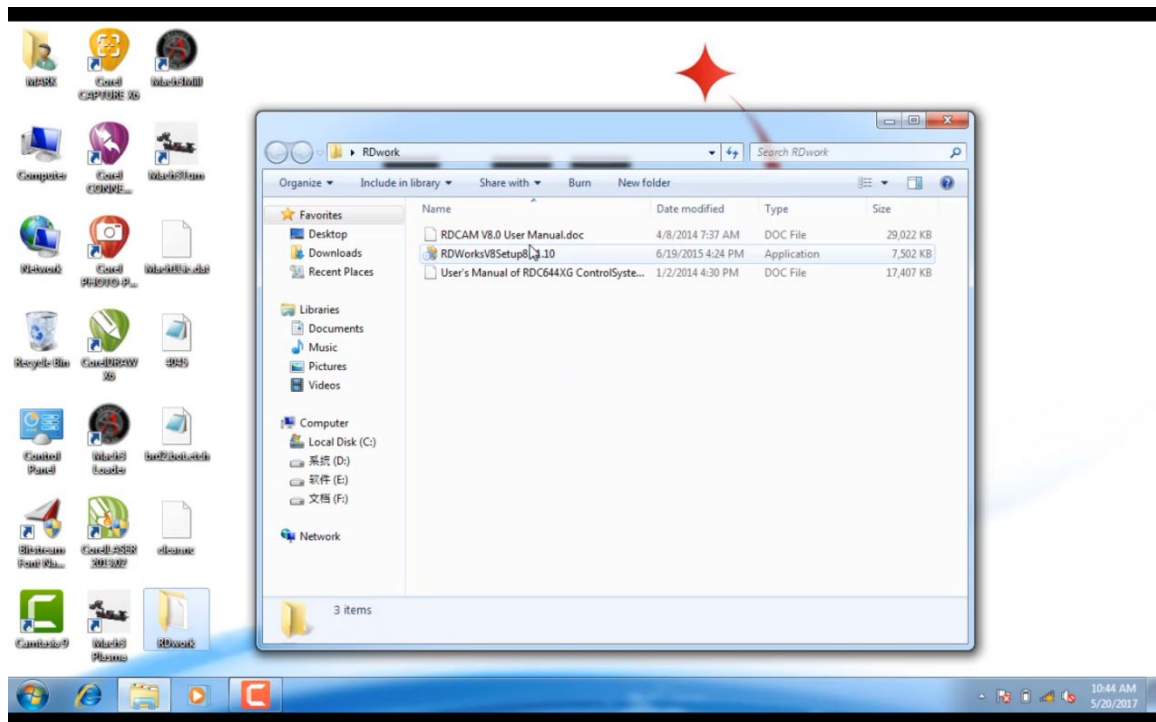

Choose "Laser work"

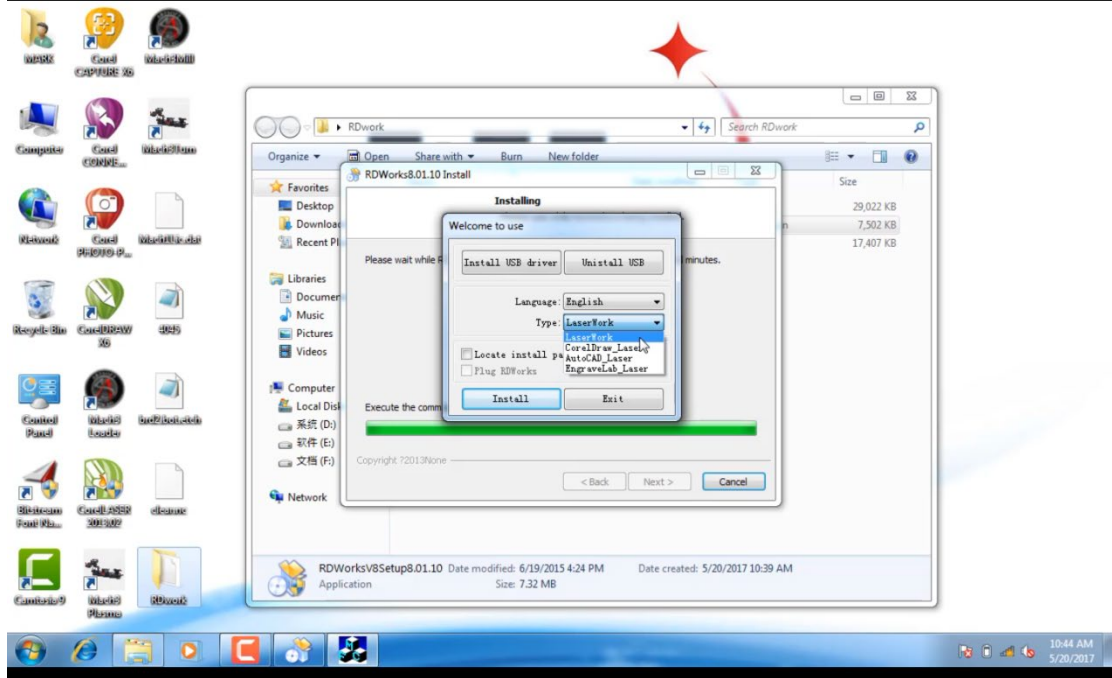

Click "Install USB driver"

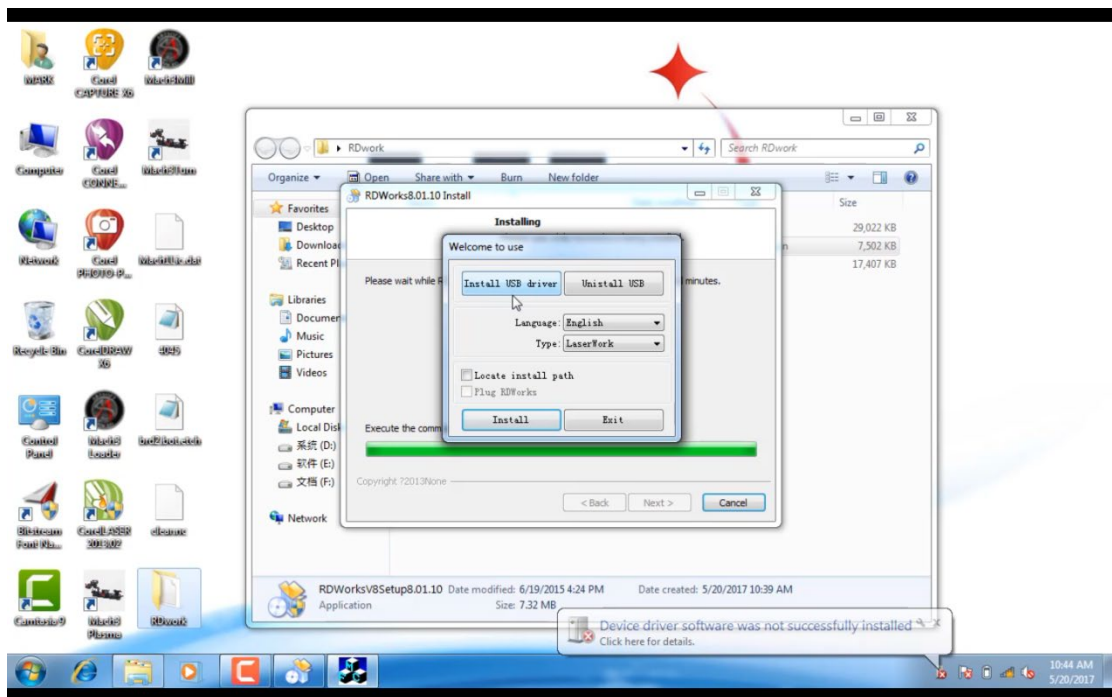

After that, the USB driver have been installed

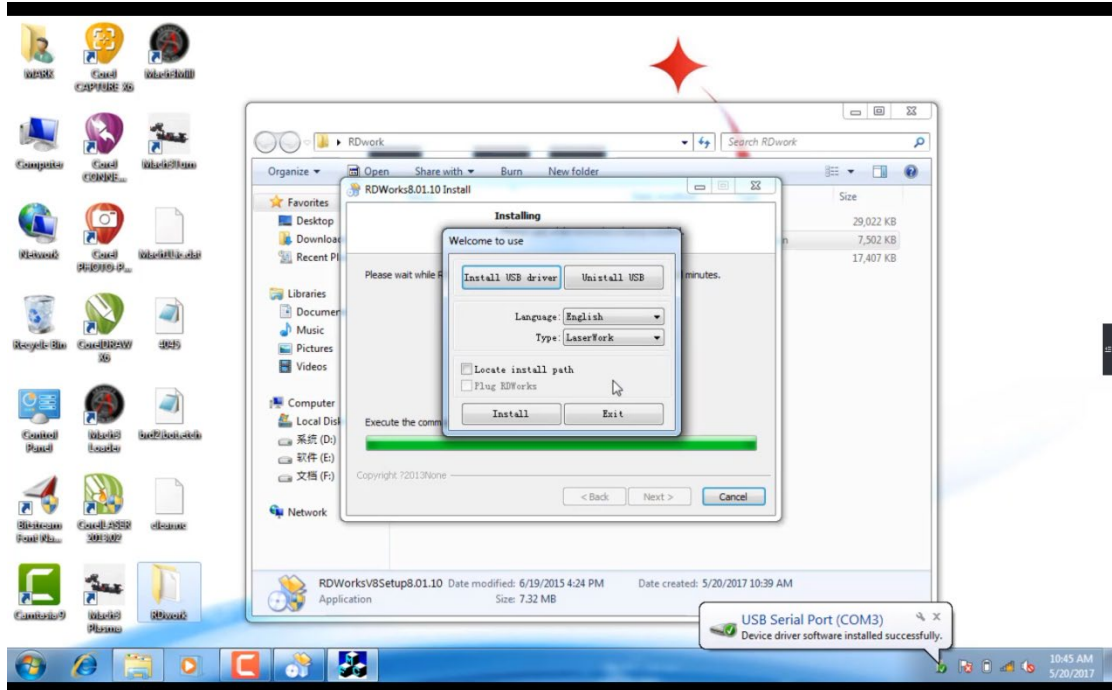

Then install the software, click "Install"

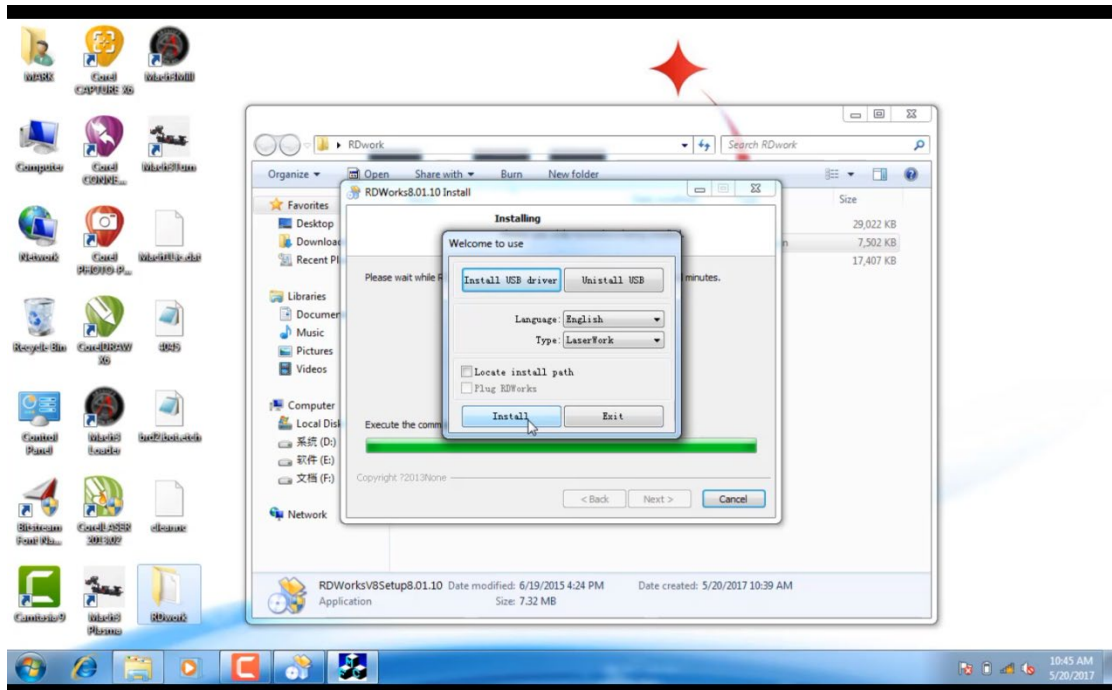

After Installment completed, click "Exit"

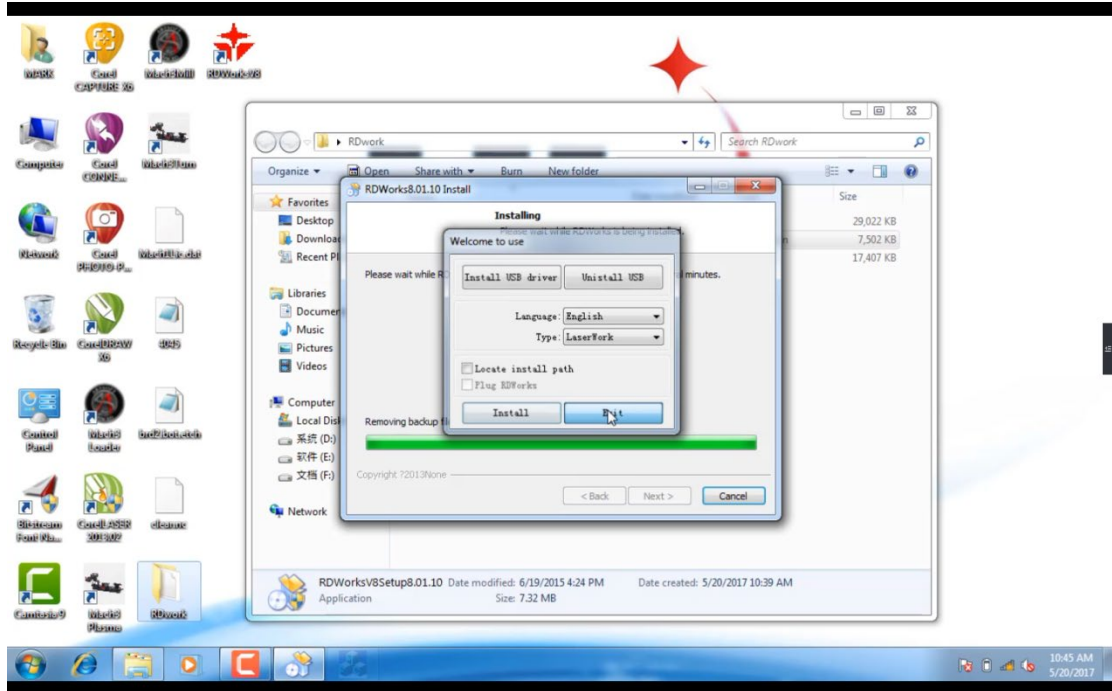

2. RDWorks Interface Briefly

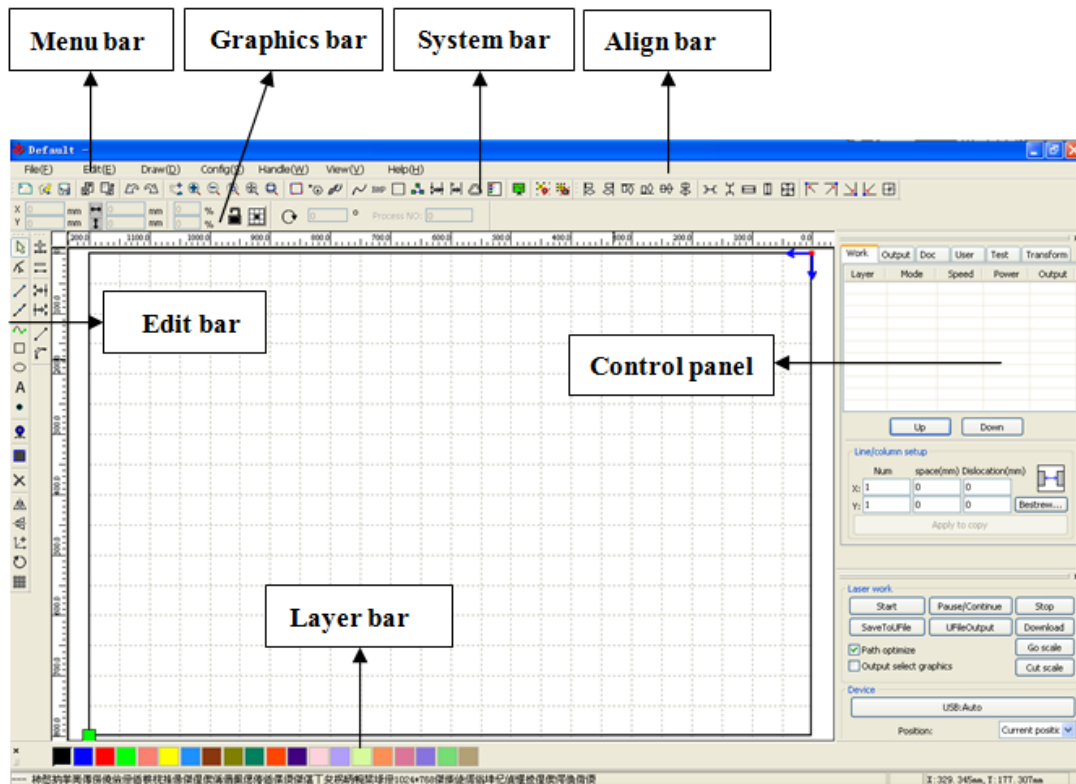

Menu Bar: The main function of this software are available through the implementation of the Menu Bar. Execute the menu command is the most basic mode of operation. Menu Bar including: Document、Edit、Draw、Setting、Processing、View and Help.

System Bar: On the System Bar, placed some most commonly command buttons which is chosen from the menu.

Graphics Bar: Graphics property bar is the basic attributes of graphics operations, including graphic location, size, scale, number processing.

Edit Bar: The Edit Bar default on the left of the work area. In the Edit Bar placed frequently used tools to make the operation more flexible and convenient.

Align Bar: Alignment of the selected objects。

Layer Bar: Change the layer of the selected objects。

Control Panel: Using the Control Panel to complete laser processing of multiple tasks, Layer parameter settings, axis control, processing ...etc.

File Import

Click menu【File】->【Import】, or click icon  The following dialog box appears. Select file, and click 【Open】。

Section V. Operations

1. PC Connection Test

Base on plug USB cable to machine. Please check whether there is good connection between RDC6445 and computer(see below)

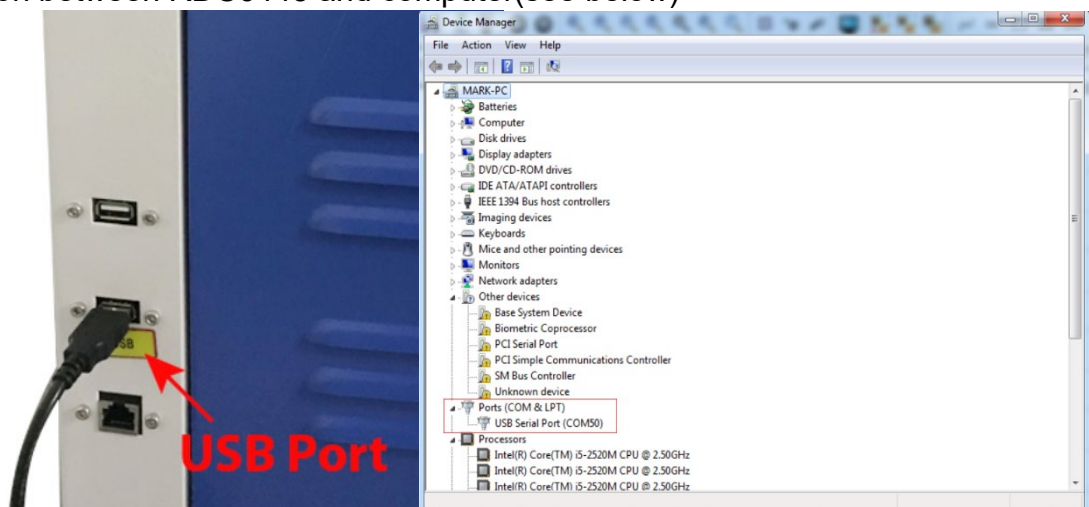

Click on setting first then use select USB:Auto connection and Exit.

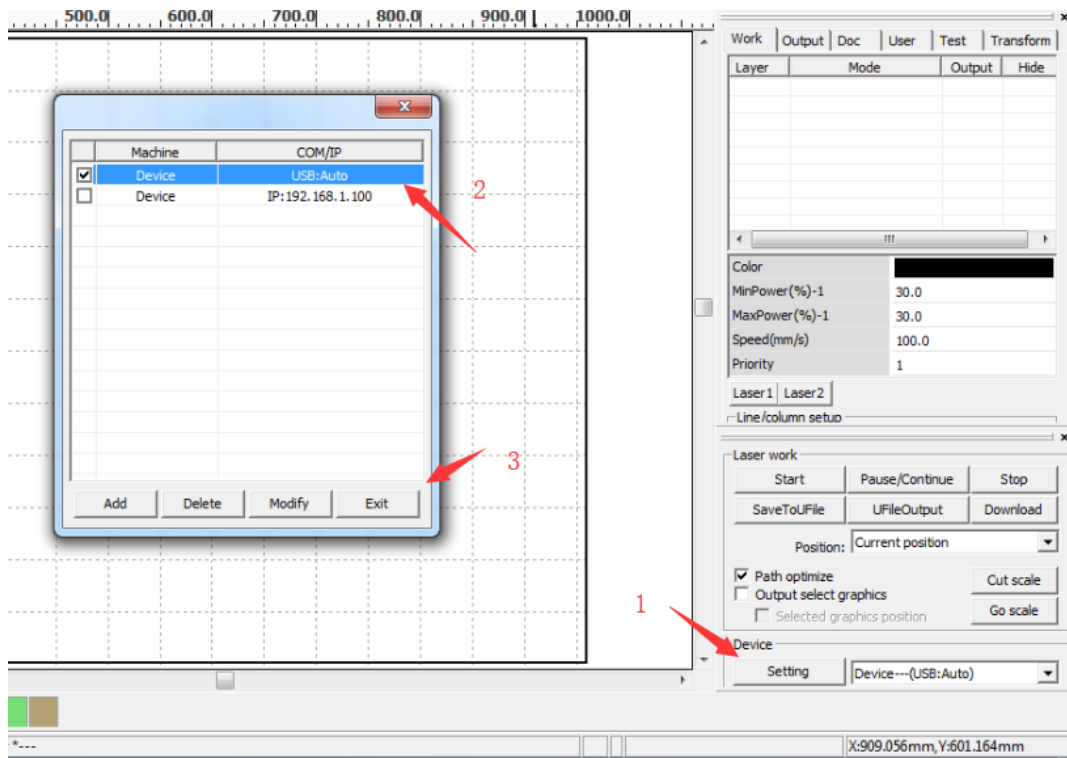

If software didn't prompt "communication error", That means connection is good.

2. Origin setting& Z height positioning

That you would use focus gauge as below or auto-focus

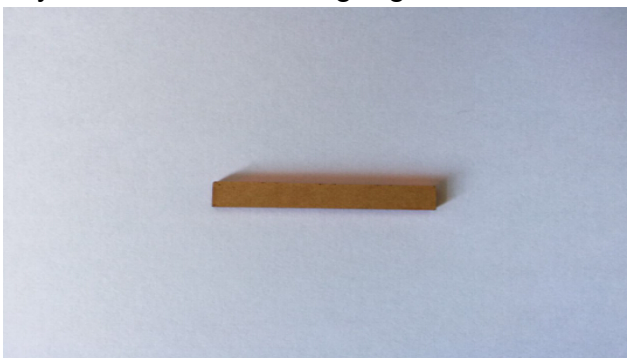

Focus Gauge and how to measure as below

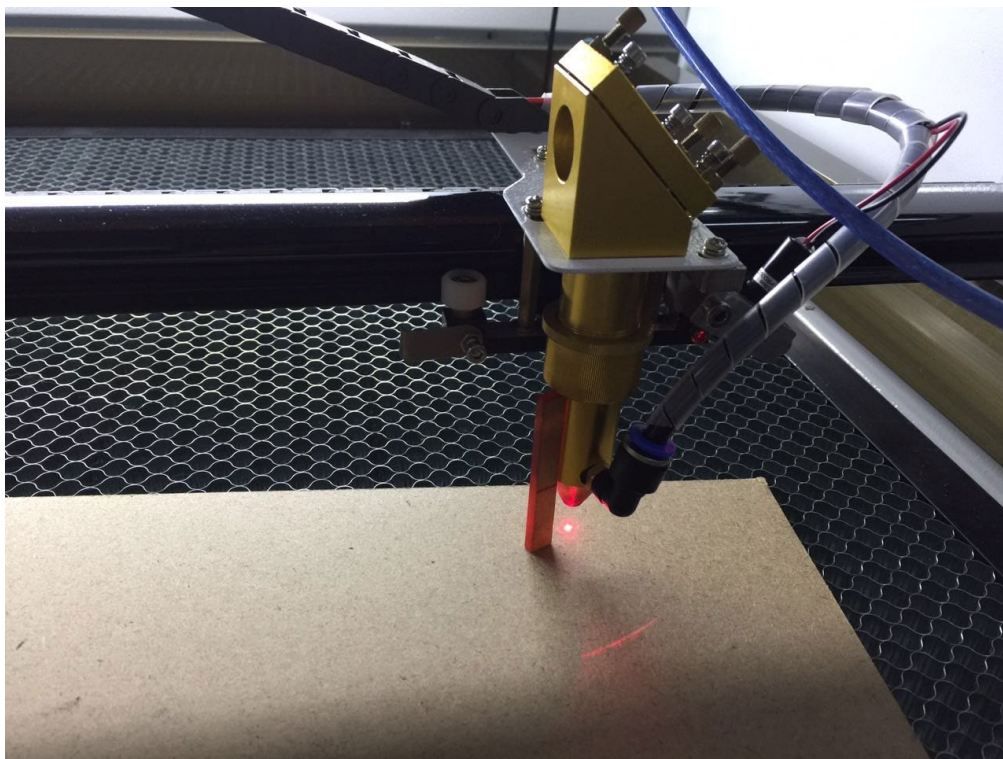
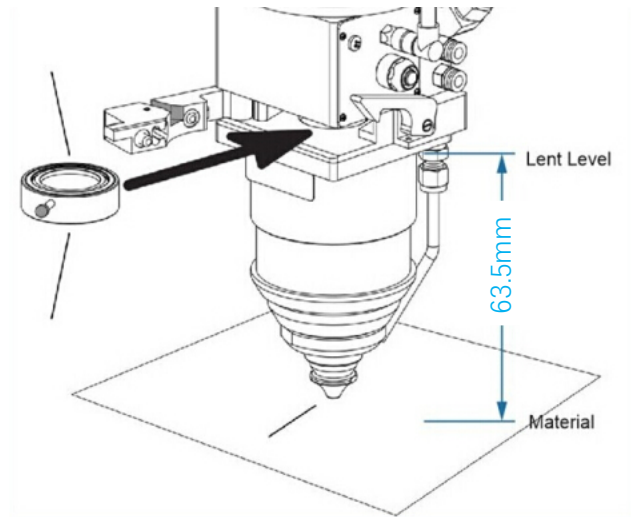

Auto-focus is a very useful function to align focal length automatically

Press Focus on the RDC6445 Panel to allow machine find focus point automatically.

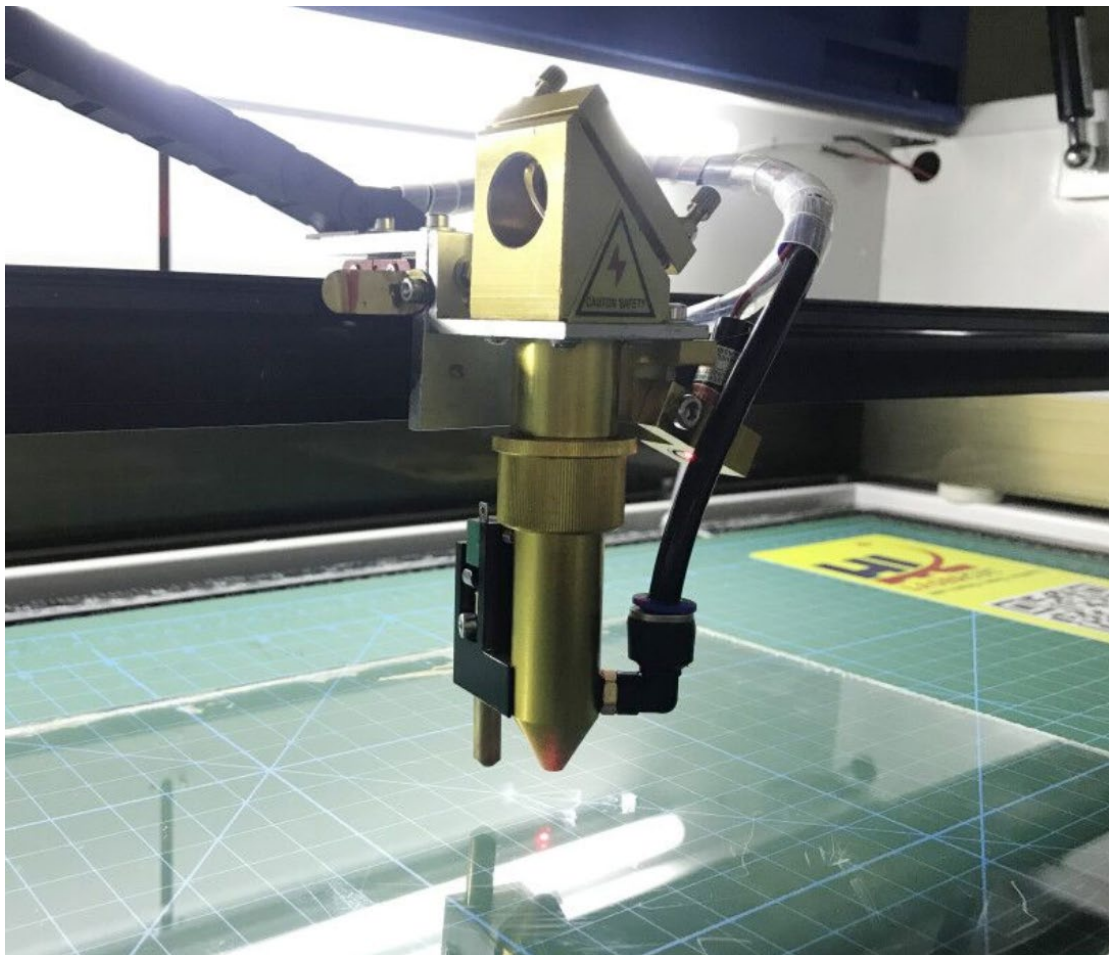
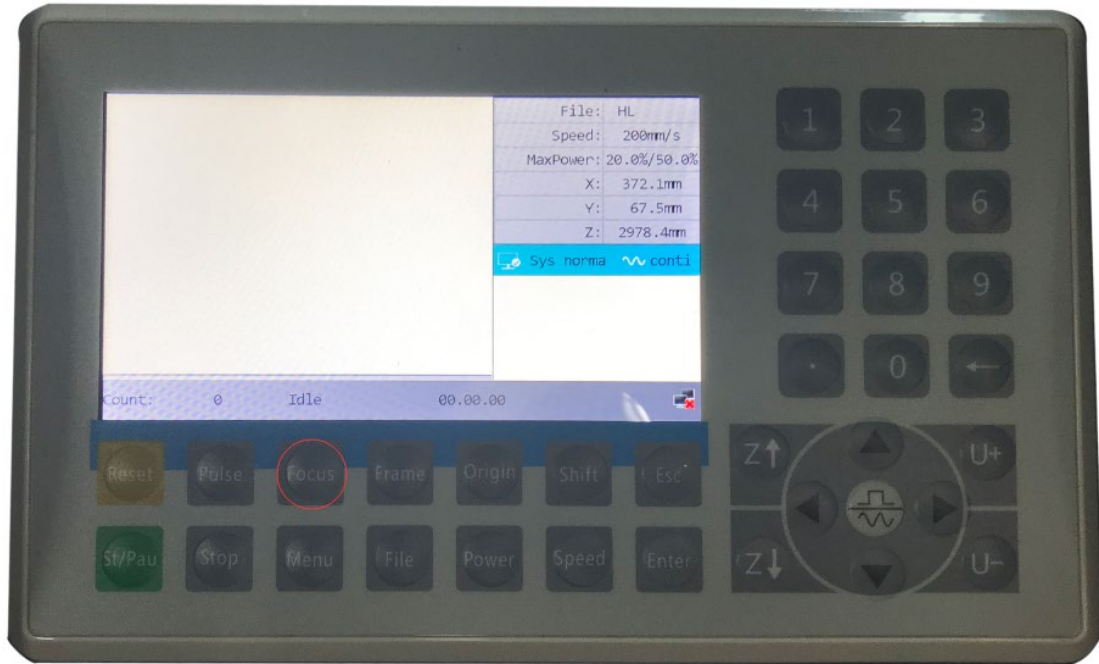

Once it's done, move laser head to correct position and press "origin" to tell laser where to start with.

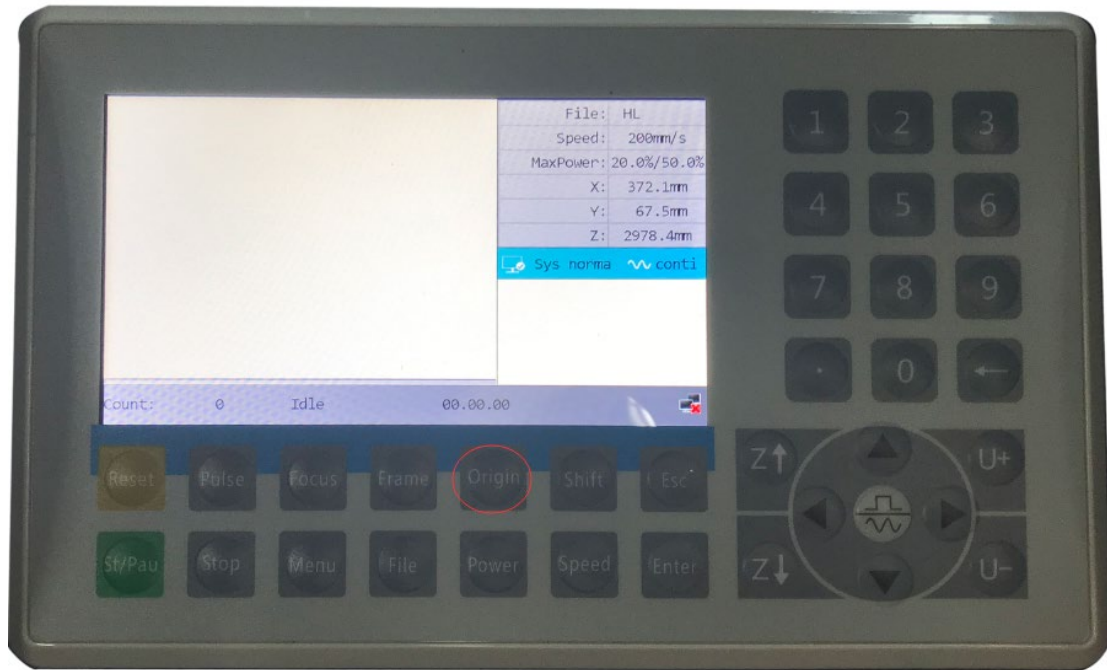

3. Pilot Run Test

First, open file "hellokitty.plt" in RDWorksV8

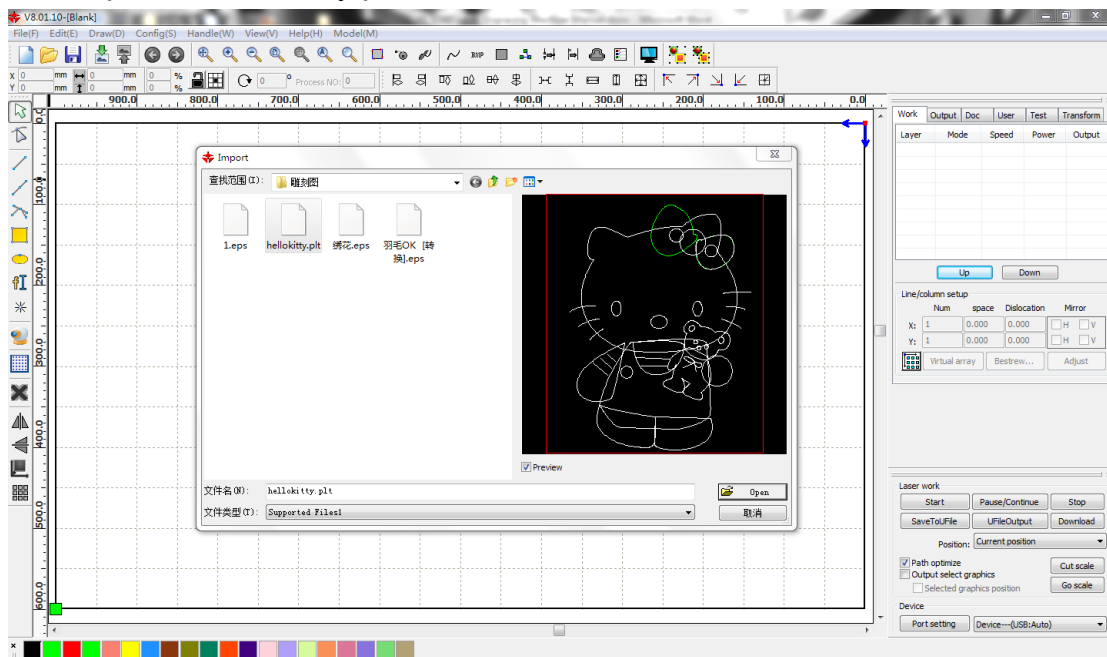

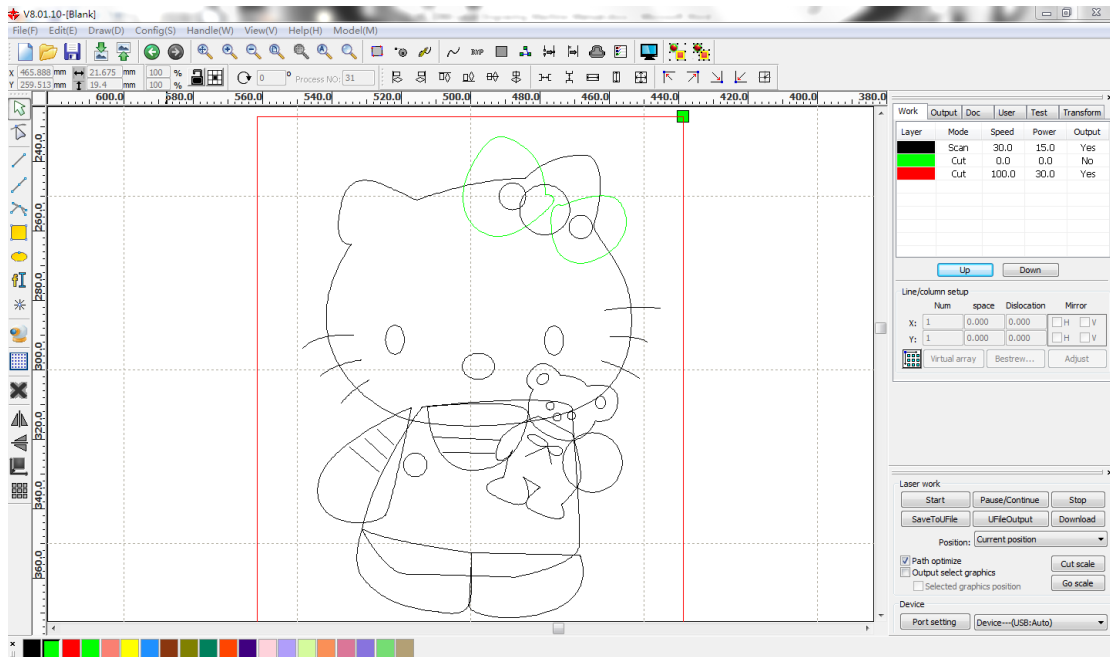

Then choose the parts you want to cutting or engraving marked by the Layer Bar. The color of object that is the color of the object contour. You can click the color button on the Layer Bar to change the color of the object has been selected. The color of the pressed button is the color of current layer.



We want to engrave the ear of the hello kitty. So we marked it as green, and setting the speed and power, our test material is 5MM acrylic, so we setting the scan mode speed as 300mm/s the power 20%.

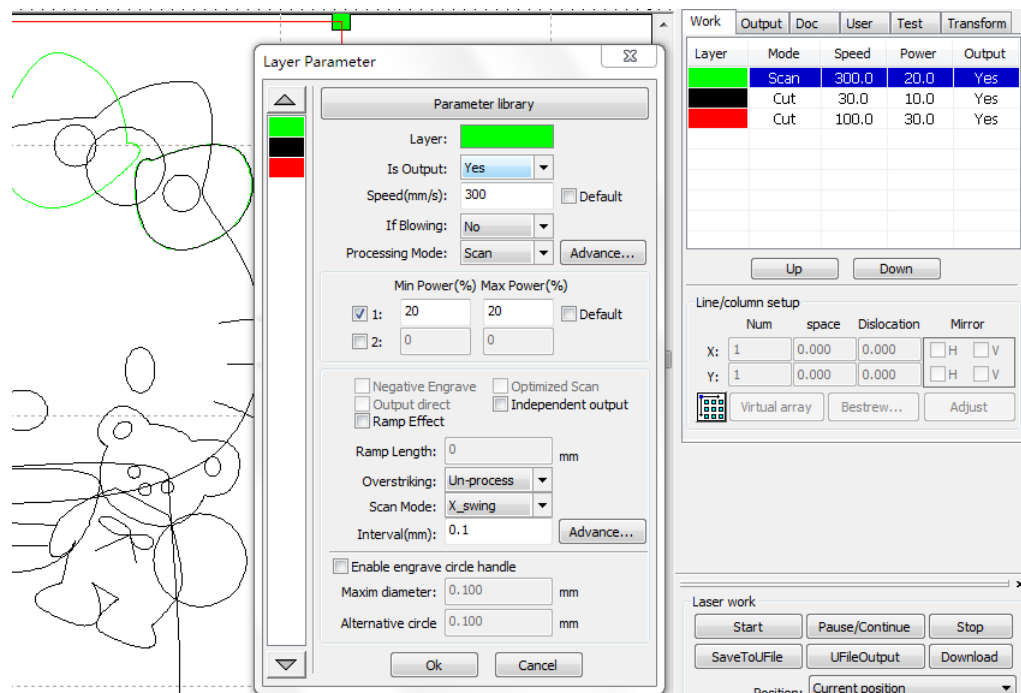

we want to engrave the contour of the hello kitty. so i marked it as black. setting cutting mode. speed 30mm/s power 10%.

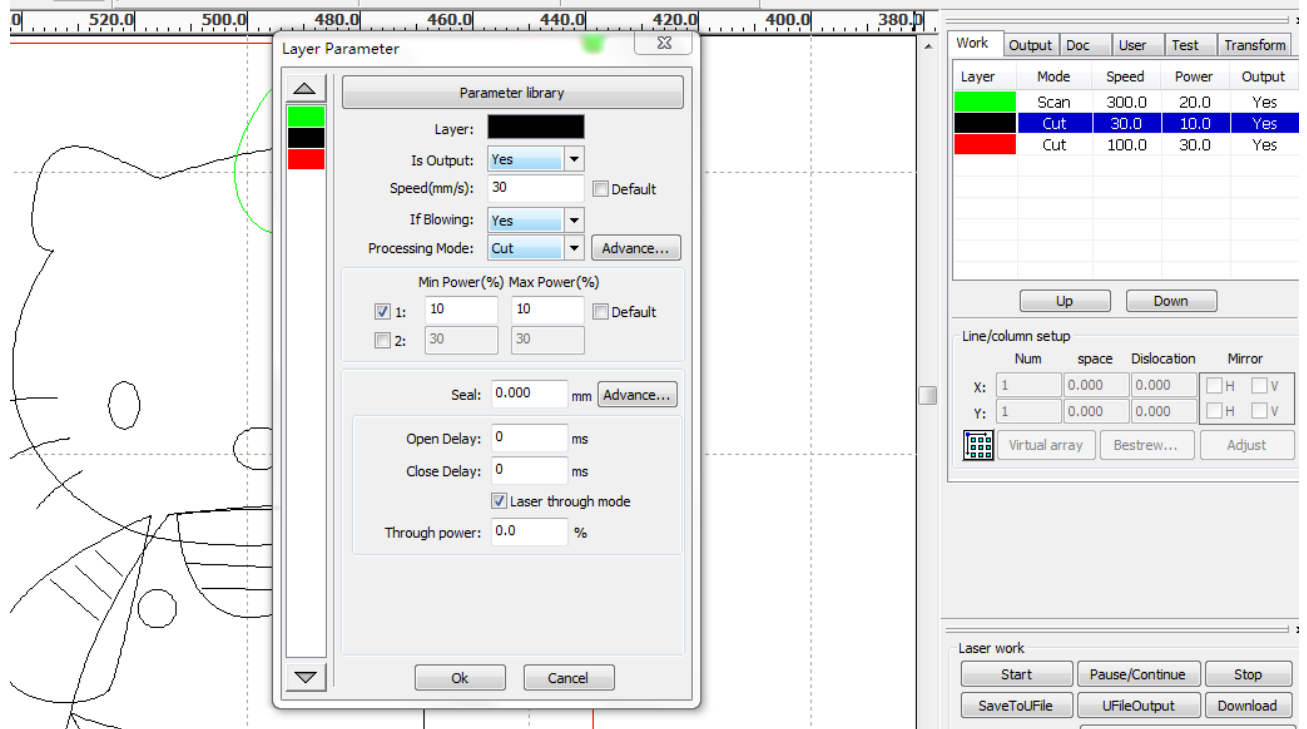

Last, I will to cutting the frame of the picture. so i marked it as Red. setting cutting mode. speed 20mm/s, power 30%.

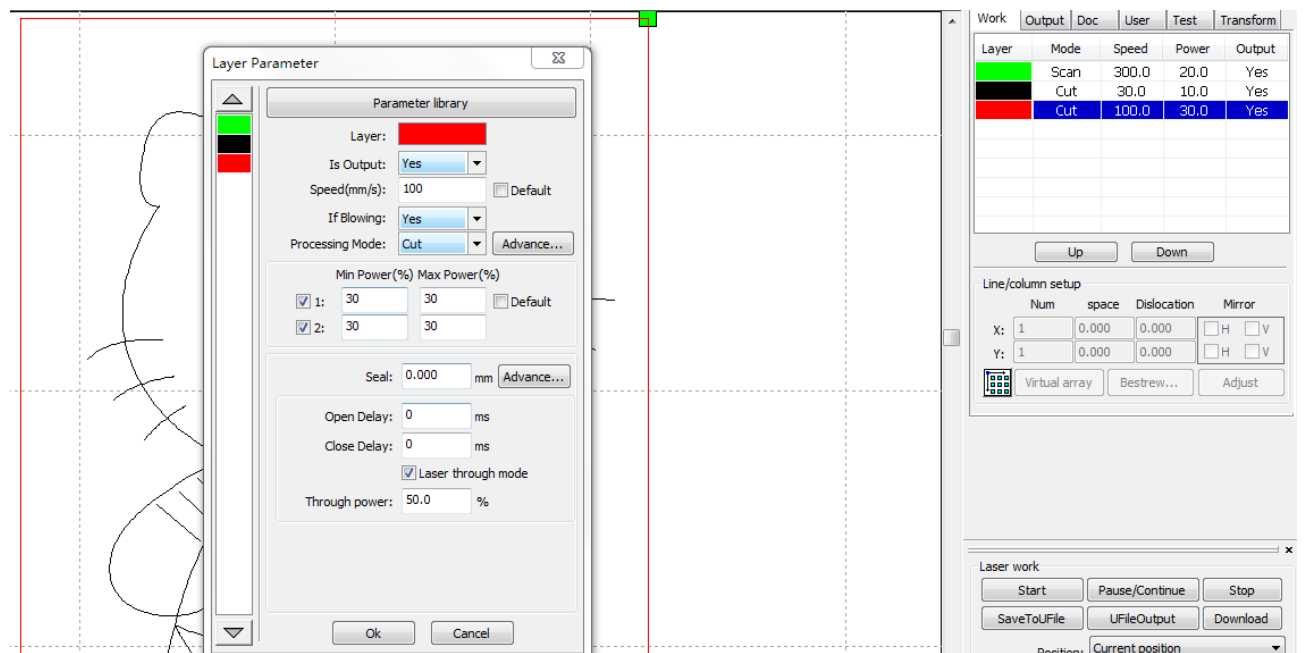

Now the setting of the file is finised, Click "start", the machine will start working!

4. U Disk Operation

UDisk function is very useful function when you start small production without PC.

a. Insert U disk as shown in blue arrow

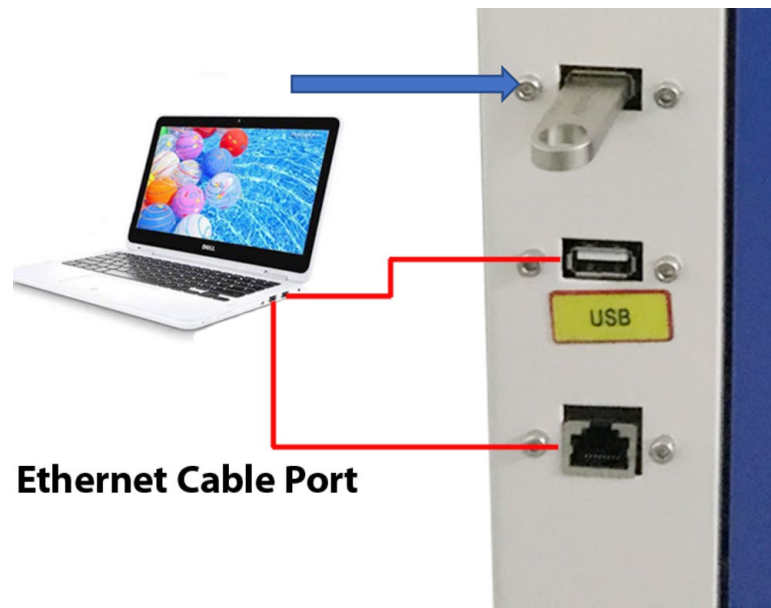

b. Click “SaveToUFile” to the U disk

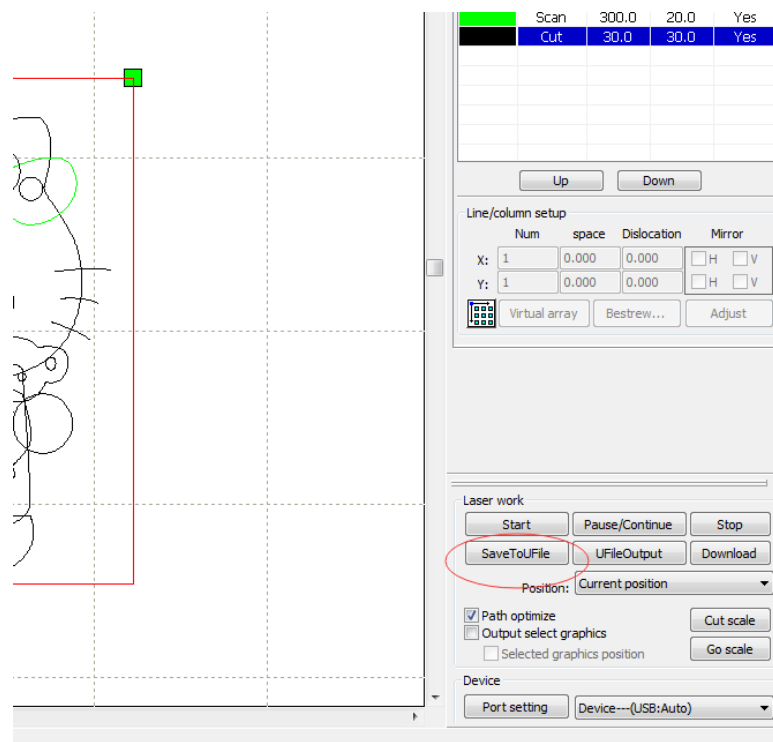

c. Press **File** on the panel

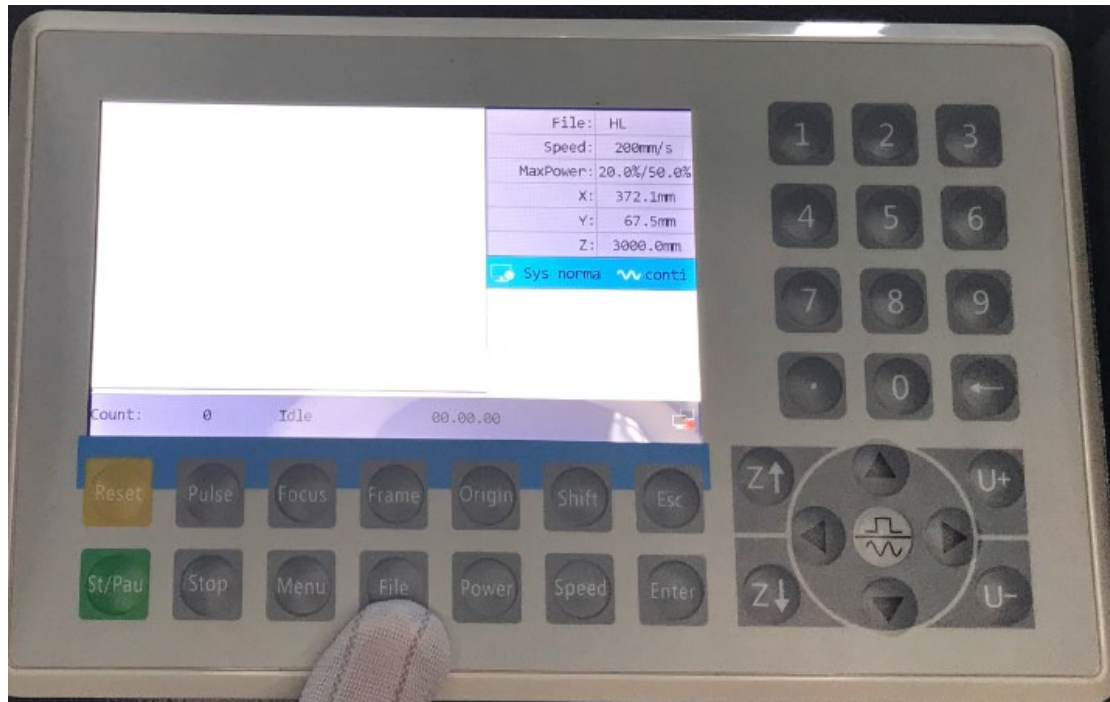

d. Move the cursor to Udisk+ by Arrow keys and Enter

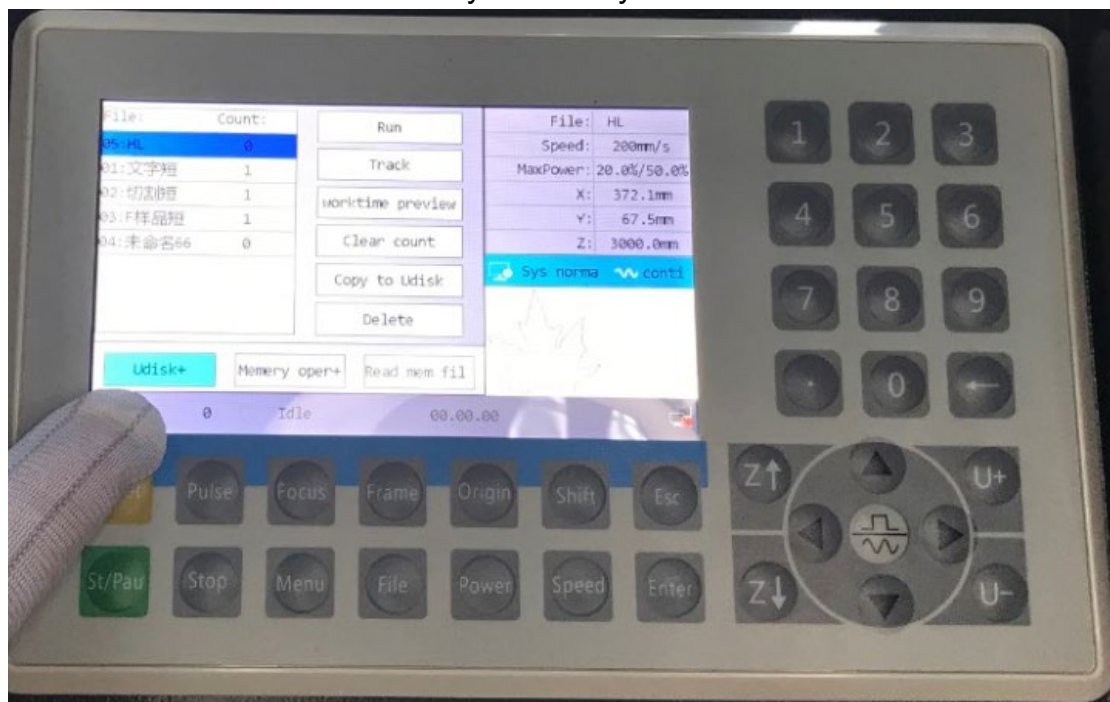

e. Then move the cursor to Read Udisk file and Enter

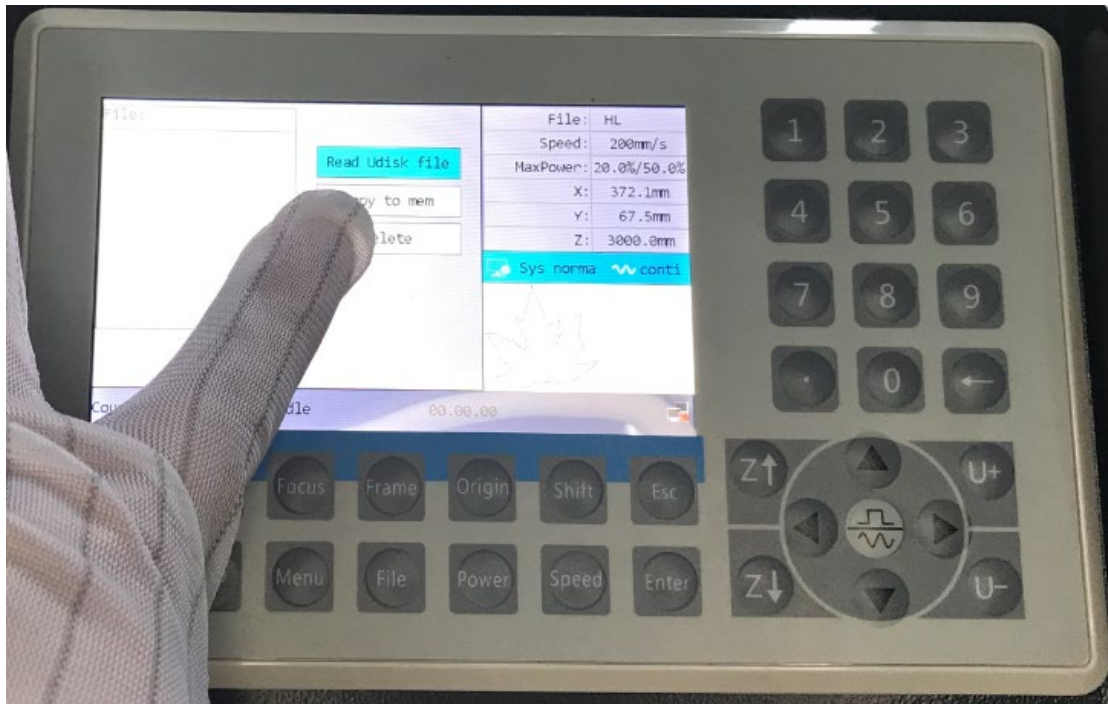

f. Select file to copy to mem and press St/Pau to start

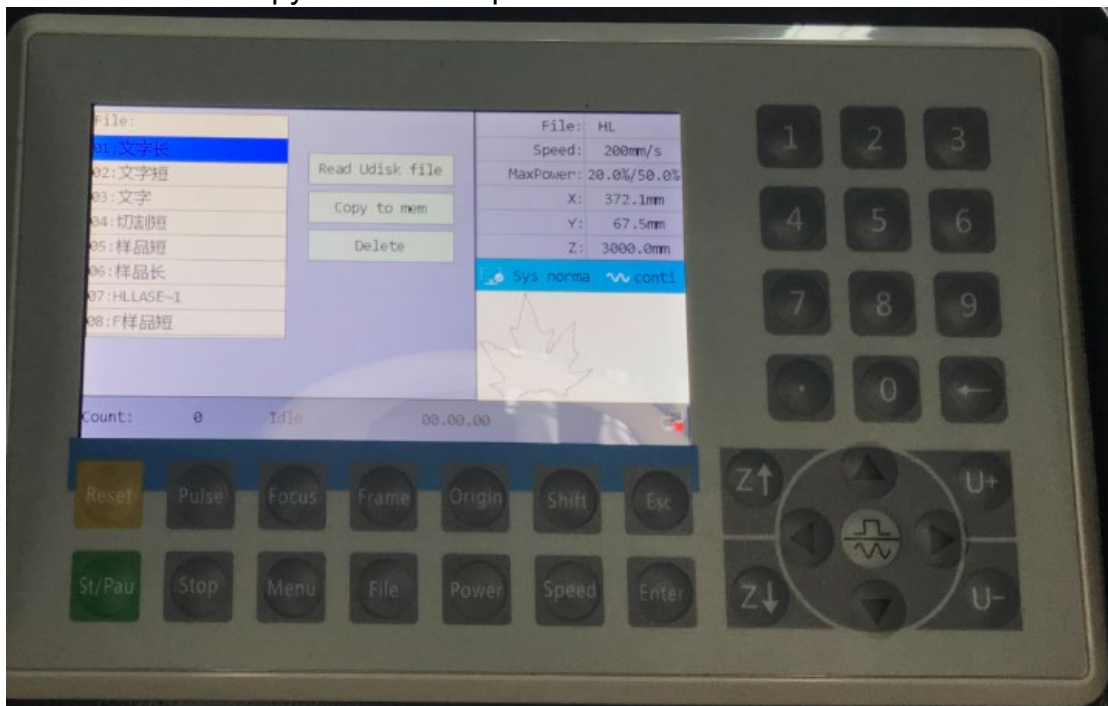

Laser machine should work as wanted!

Section VI. FAQ

1. Why Machine does not move when power on?

Answer: 1.Check the power cable good connection or not 2.Check the panel paraments if it is correct

2. Why No laser beam come out?

Answer: Please check laser tube whether physical damage. Water protection switch break?

3. Why X axis stop unexpected during working?

Answer: Please swap X and Y axis stepper motor. If problem on Y axis, it is damaged stepper driver.

4. What should I do software prompt "communication error"?

Answer: If it worked all good but had problem now, please consider change cable.

5. What is problem control panel blinking?

Answer: Please check if anywhere short circuit.

6. How do I do laser head can't get back to home position?

Answer: Please check home limit switch if works well.

Electrical Diagram

